

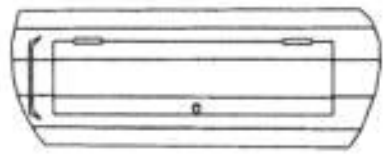

9000  
Th=3mm



Door Detail



Top Section

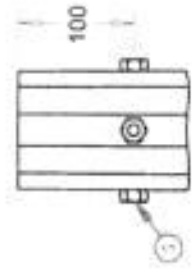

Nut Detail

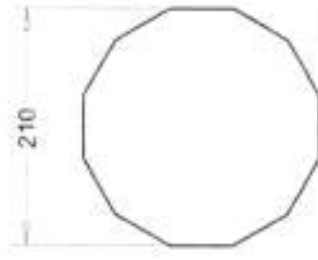

Bottom Section

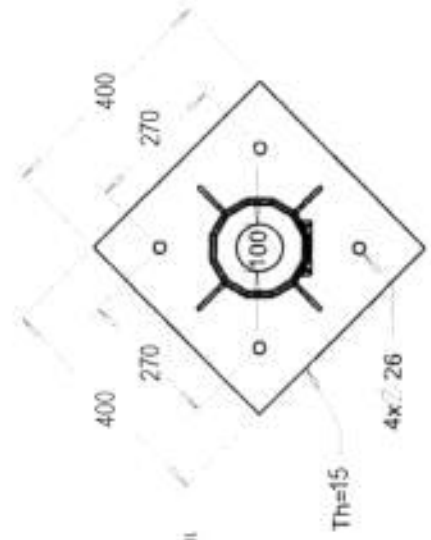

Detail 2

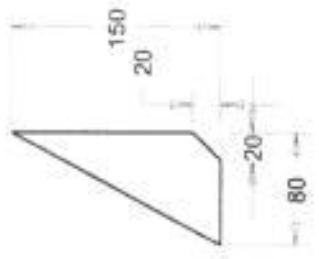

Gusset Section

NO	DESCRIPTION	QTY	Material
7	Type CI Welding : GMAW (MAG)	-	-
6	Coating : H.D.G ASTM A-123	-	-
5	Hexagonal Nut_ M10	4	CR45
4	Entrance 400x100 (Projected View)	1	-
3	Gusset 1/2 (150x80x8)	4	ST37
2	Base Plate 400*400 *15	1	ST37
1	Body	1	ST37

REVISION

DESCRIPTION	DATE	INIT	DATE	SIGN

9m Pole For Installing Street Lighting

NO	DATE	BY	CHK	APP	DATE	SCALE	PROJ. NO.	REV. NO.	REV. DATE	REVISION

CODE	PROJECT	SCALE	DATE	REV. NO.	REV. DATE

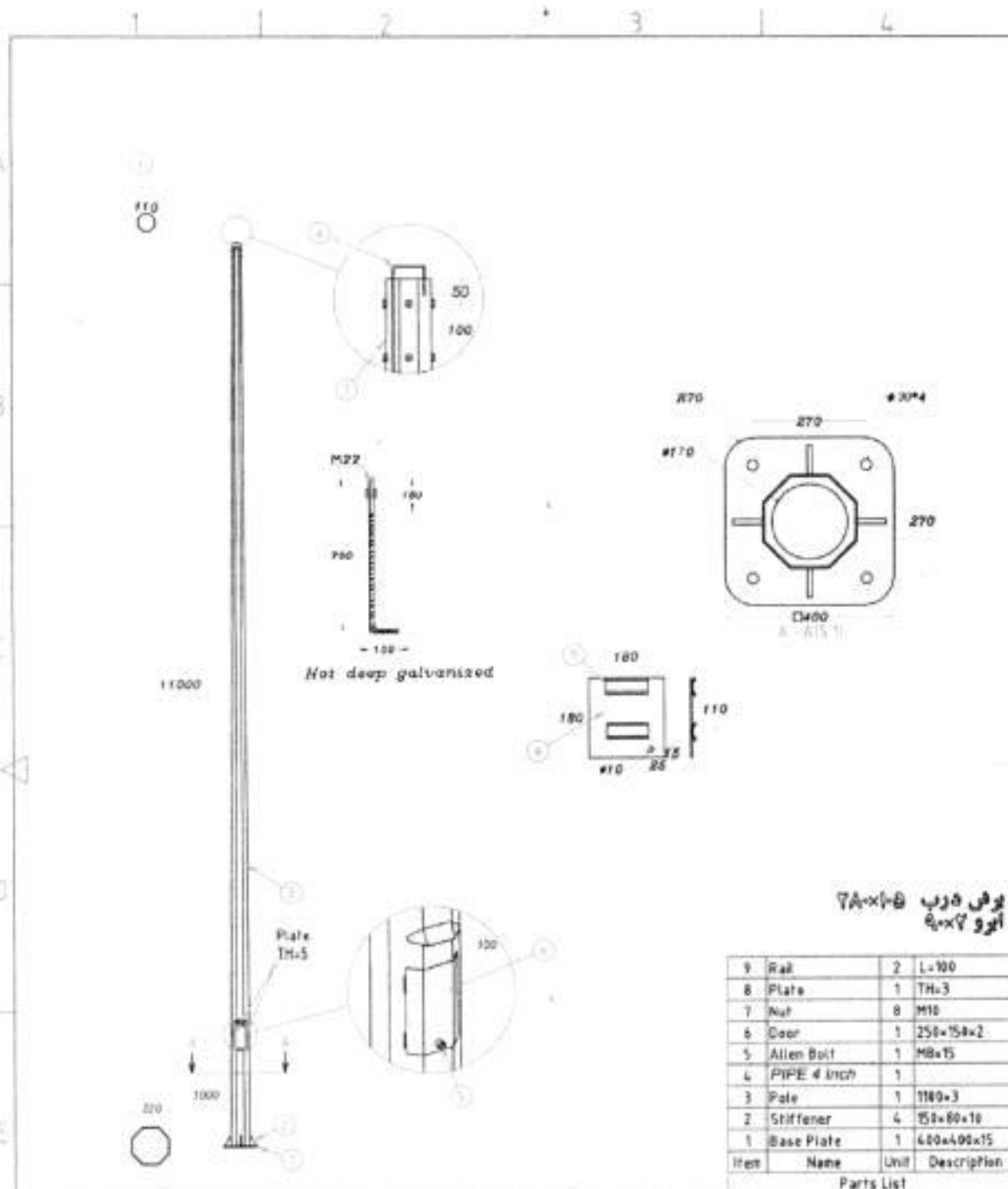

پوش و درب  
آبرو ۷×۷  
۷۸×۷۸

Item	Name	Unit	Description
9	Rail	2	L=100
8	Plate	1	TH-3
7	Nut	8	M10
6	Door	1	250x150x2
5	Allen Bolt	1	M8x15
4	PIPE 4 inch	1	
3	Pole	1	1100x3
2	Stiffener	4	150x80x10
1	Base Plate	1	400x400x15

Parts List

DRAWN BY	DRAWN BY	CHEKED BY	APPROVED 1	DATE	UNIT	DWG NO	MATERIAL	SCALE
					mm		Mild steel	1:1
Pole 11M					FILE NAME	WEIGHT(kg)	SHEET	
Modification1	Date							
Modification2	Date							
Modification3	Date							

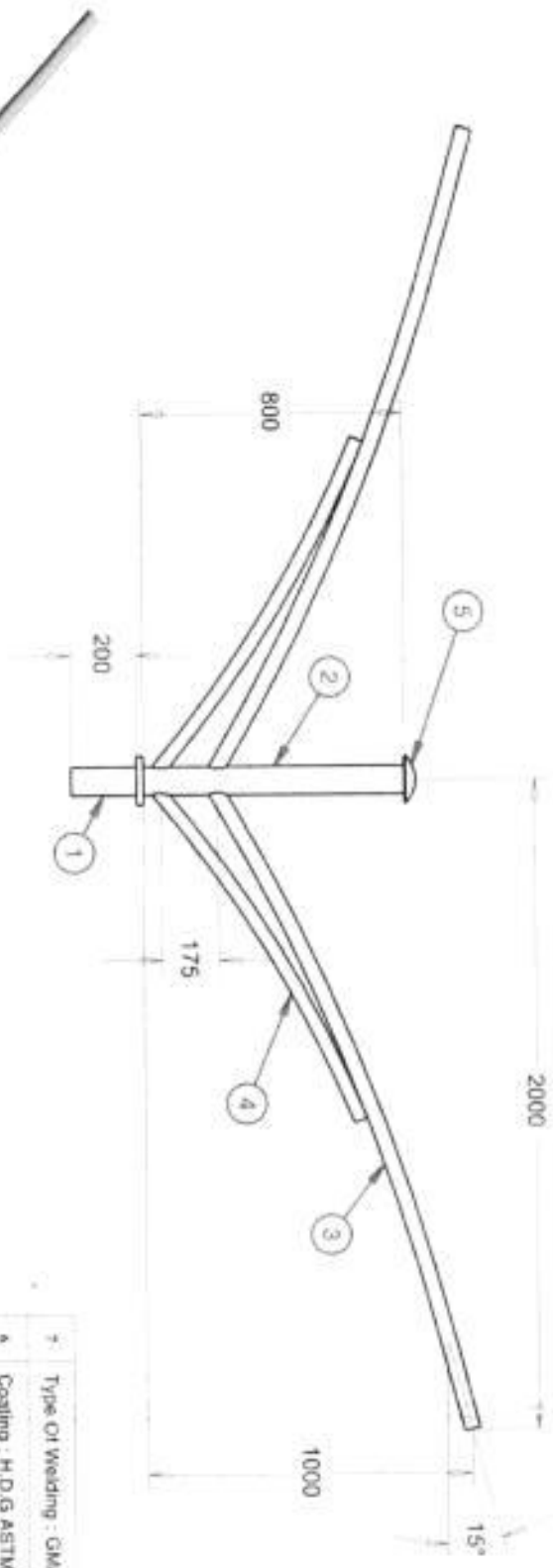

NO	DESCRIPTION	QTY	Material
1	3" Pipe Th=3	1	ST37
2	3" Pipe Th=3	1	ST37
3	3" Pipe Th=3	1	ST37
4	1.25" Pipe Th=3	2	ST37
5	1.5" Pipe Th=2	2	ST37
6	Cap	1	-
7	Type Of Welding : GMAW (MAG)	-	-
8	Coating : H.D.G ASTM A-123	-	-

REVISION

NO	DESCRIPTION	DATE	BY	CHKD

DESCRIPTION	DATE	BY	CHKD
DESIGNED :			
DRAWN :			
CHECKED :			
APPROVED 1 :			
APPROVED 2 :			

Decorative Pipe Bracket

SCALE :	1:1
DATE :	
METRIC :	

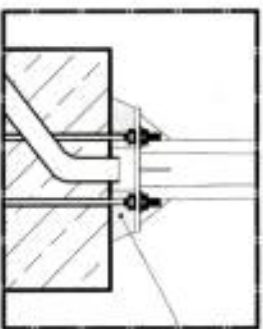
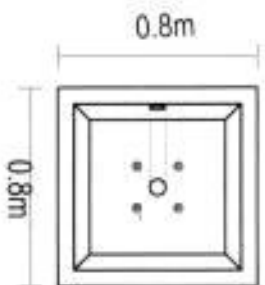
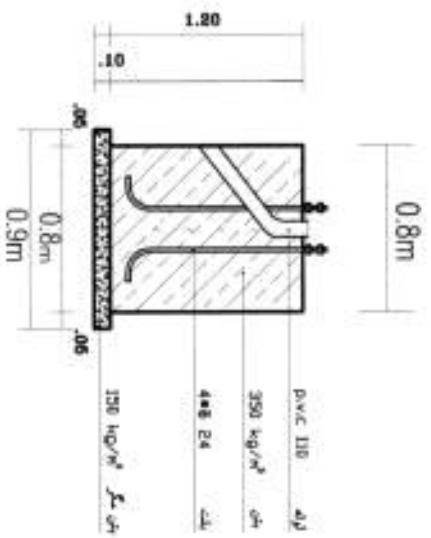

کریته انورادینا  
مقدار طبقه سیمه 250 kg/m³

شکل اندازه گذاری و اجرایی فلنسون پایه های روشنی ۹ متری

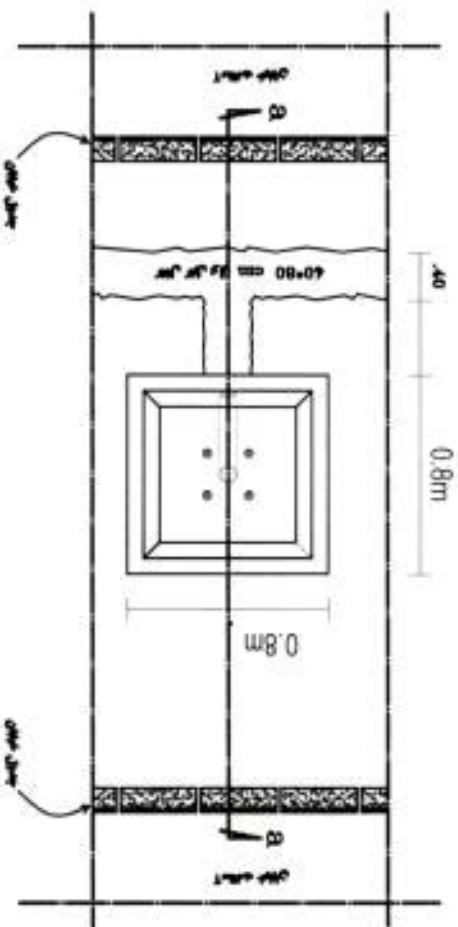
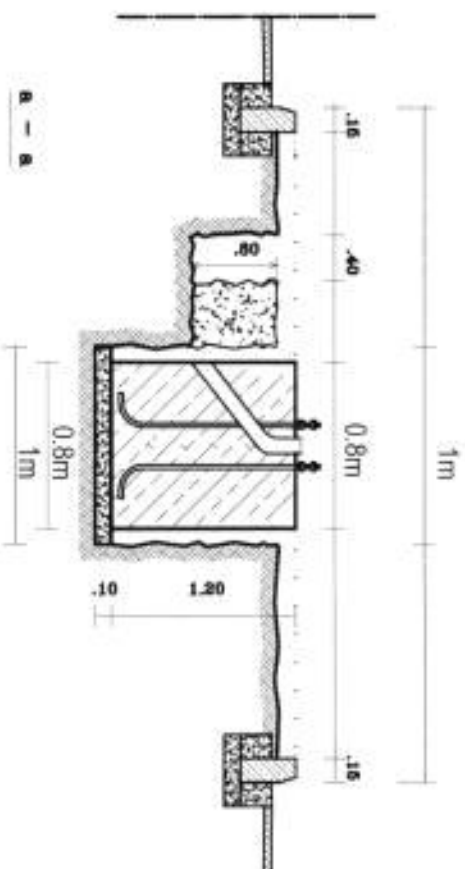

شکل اندازه گذاری و اجرایی فلنسون پایه های روشنی ۹ متری

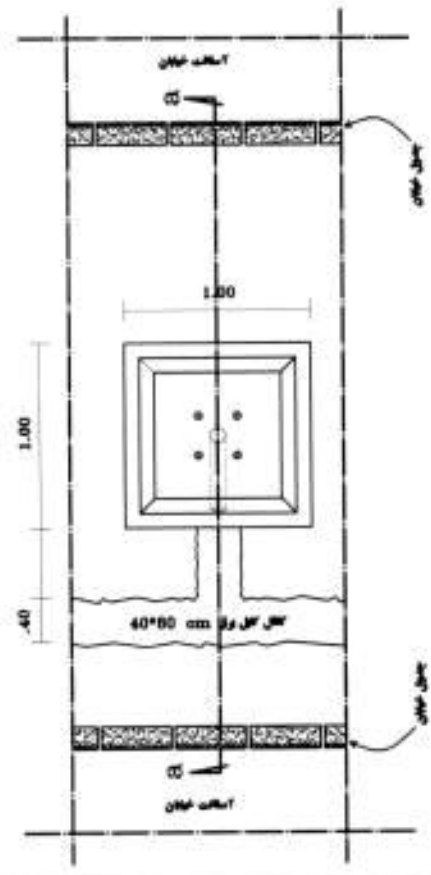
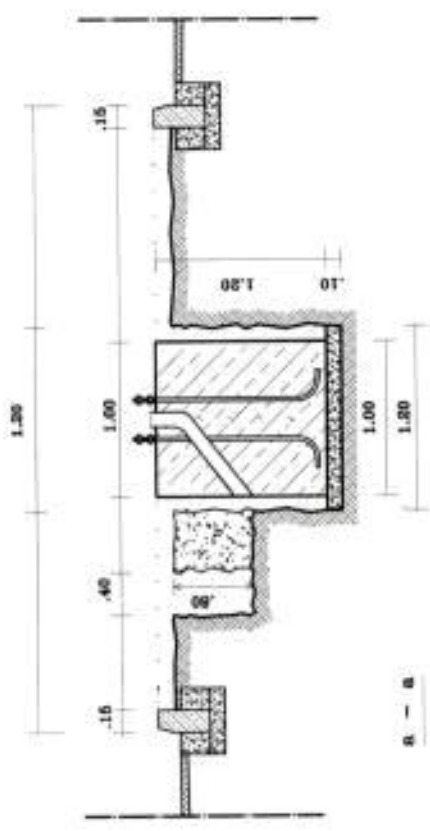

هکابل اندازه گذاری و اجرایی فنداسیون پایه های روشنی (امتری)

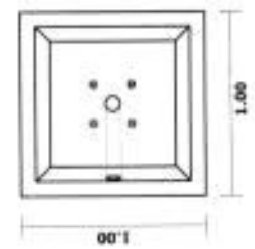
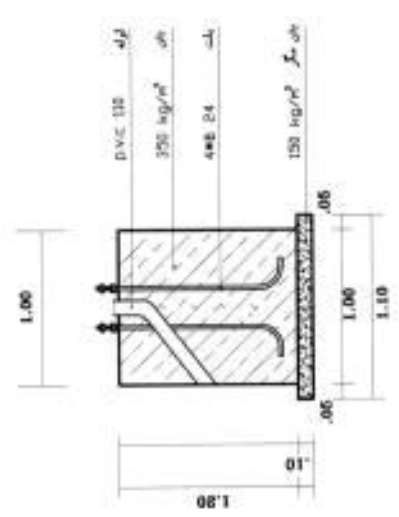

هکابل اندازه گذاری و اجرایی فنداسیون پایه های روشنی (امتری)